

# Geometry Drill

Think you have mastered these concepts? Try your hand at the following problems and check your work after you have finished. You can find the answers in Part V.

1 of 15

Which of the following could be the degree measures of two angles in a right triangle?

Indicate all such angles.

- $20^\circ$  and  $70^\circ$   
  $30^\circ$  and  $60^\circ$   
  $45^\circ$  and  $45^\circ$   
  $55^\circ$  and  $55^\circ$   
  $75^\circ$  and  $75^\circ$

2 of 15

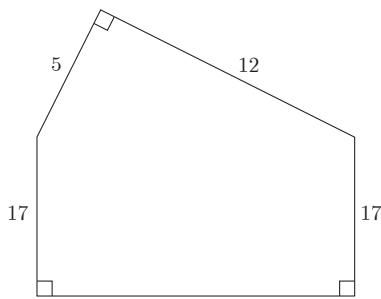

What is the perimeter of the figure above?

- 51  
 64  
 68  
 77  
 91

3 of 15

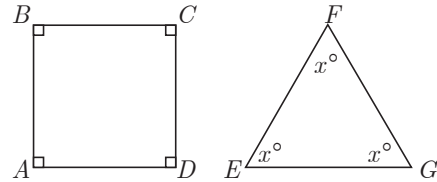

$$AB = BC = EG$$

$$FG = 8$$

**Quantity A****Quantity B**The area of square  $ABCD$ 

32

- Quantity A is greater.  
 Quantity B is greater.  
 The two quantities are equal.  
 The relationship cannot be determined from the information given.

4 of 15

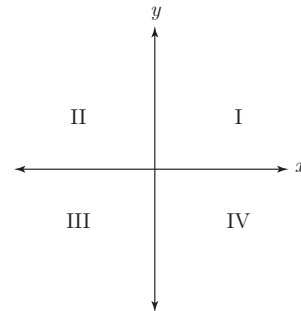

$(a, 6)$  is a point (not shown) in Quadrant I.  
 $(-6, b)$  is a point (not shown) in Quadrant II.

**Quantity A****Quantity B** $a$  $b$ 

- Quantity A is greater.  
 Quantity B is greater.  
 The two quantities are equal.  
 The relationship cannot be determined from the information given.

5 of 15

A piece of twine with length of  $t$  is cut into two pieces. The length of the longer piece is 2 yards greater than 3 times the length of the shorter piece. Which of the following is the length, in yards, of the longer piece?

- $\frac{t+3}{3}$
- $\frac{3t+2}{3}$
- $\frac{t-2}{4}$
- $\frac{3t+4}{4}$
- $\frac{3t+2}{4}$

6 of 15

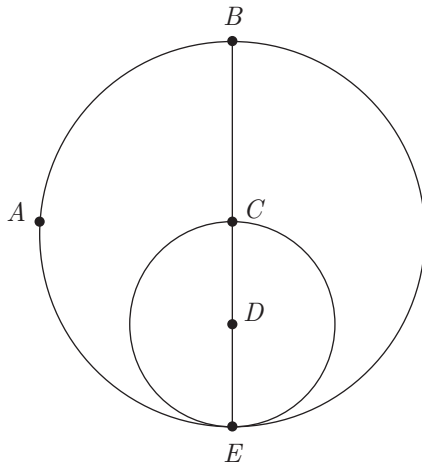

The circle with center  $D$  is drawn inside the circle with center  $C$ , as shown in the figure above. If  $CD = 3$ , what is the area of semicircle  $EAB$ ?

- $\frac{9}{2}\pi$
- $9\pi$
- $12\pi$
- $18\pi$
- $36\pi$

7 of 15

For the final exam in a scuba diving certification course, Karl navigates from one point in a lake to another. Karl begins the test  $x$  meters directly beneath the boat and swims straight down toward the bottom of the lake for 8 meters. He then turns to his right and swims in a straight line parallel to the surface of the lake and swims 24 meters, at which point he swims directly from his location, in a straight line, back to the boat. If the distance that Karl swims back to the boat is 26 meters, what is the value of  $x$ ?

meters

Click on the answer box and type in a number.  
Backspace to erase.

8 of 15

**Quantity A****Quantity B**

The circumference of a circular region with radius  $r$

The perimeter of a square with side  $r$

- Quantity A is greater.
- Quantity B is greater.
- The two quantities are equal.
- The relationship cannot be determined from the information given.

9 of 15

Triangle  $ABC$  is contained within a circle with center  $C$ . Points  $A$  and  $B$  lie on the circle. If the area of circle  $C$  is  $25\pi$ , and the measure of angle  $ACB$  is  $60^\circ$ , which of the following are possible lengths for side  $AB$  of triangle  $ABC$ ?

Indicate all such lengths.

- 3
- 4
- 5
- 6
- 7

10 of 15

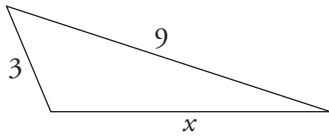

**Quantity A**

$x$

**Quantity B**

5.9

- Quantity A is greater.
- Quantity B is greater.
- The two quantities are equal.
- The relationship cannot be determined from the information given.

11 of 15

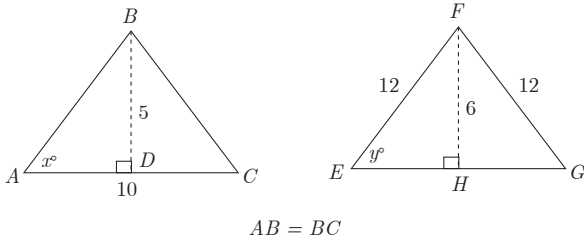

**Quantity A**

$x$

**Quantity B**

$y$

- Quantity A is greater.
- Quantity B is greater.
- The two quantities are equal.
- The relationship cannot be determined from the information given.

12 of 15

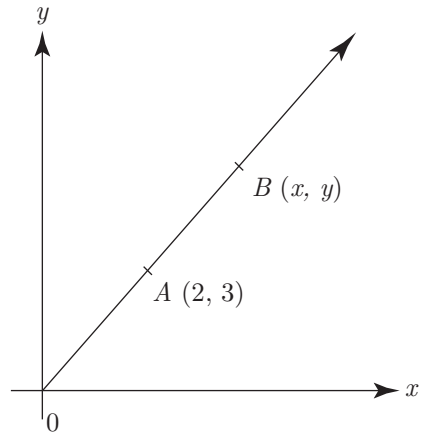

Given points  $A(2, 3)$  and  $B(x, y)$  in the rectangular coordinate system above, if  $y = 4.2$ , then  $x =$

- 2.6
- 2.8
- 2.9
- 3.0
- 3.2

13 of 15

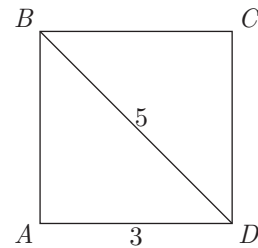

In rectangle  $ABCD$  above, which of the following is the area of the triangle  $ABD$  ?

- 6
- 7.5
- 10
- 12
- 15

14 of 15

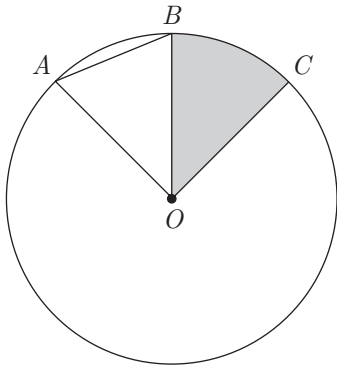

The circle above has a center  $O$ .  
 $\angle AOB = \angle BOC$

**Quantity A**

The area of  
 triangle  $AOB$

**Quantity B**

The area of the  
 shaded region

- Quantity A is greater.
- Quantity B is greater.
- The two quantities are equal.
- The relationship cannot be determined from the information given.

15 of 15

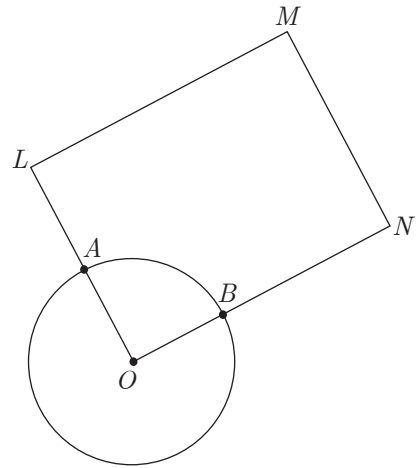

The circumference of the circle with center  $O$  shown above is  $15\pi$ .  $LMNO$  is a parallelogram and  $\angle OLM = 108^\circ$ . What is the length of minor arc  $AB$ ?

- $15\pi$
- $9\pi$
- $3\pi$
- $2\pi$
- $\pi$